

**magnoplast**

**КАТАЛОГ**

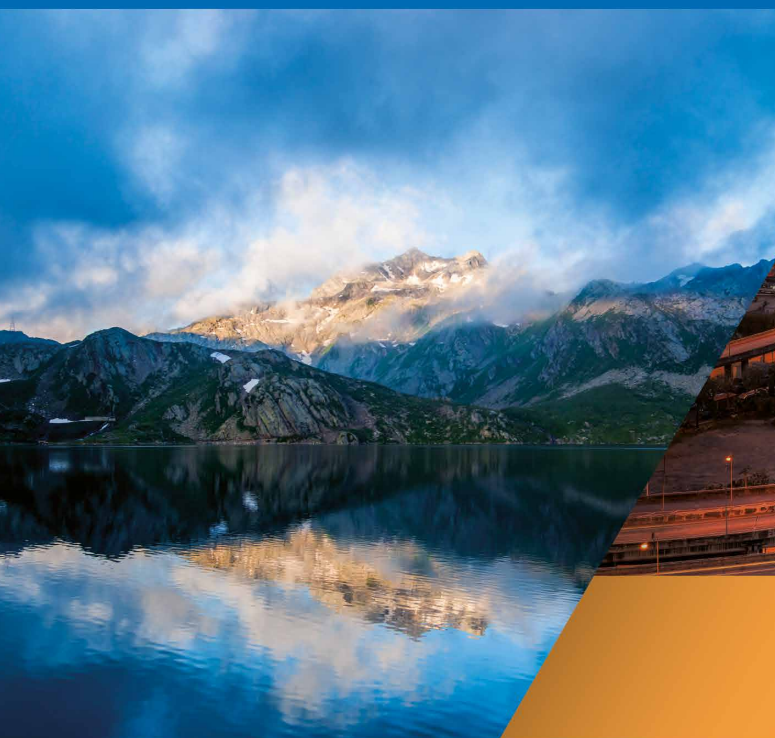

**KG**

**СИСТЕМА  
ЗОВНІШНЬОЇ  
КАНАЛІЗАЦІЇ**

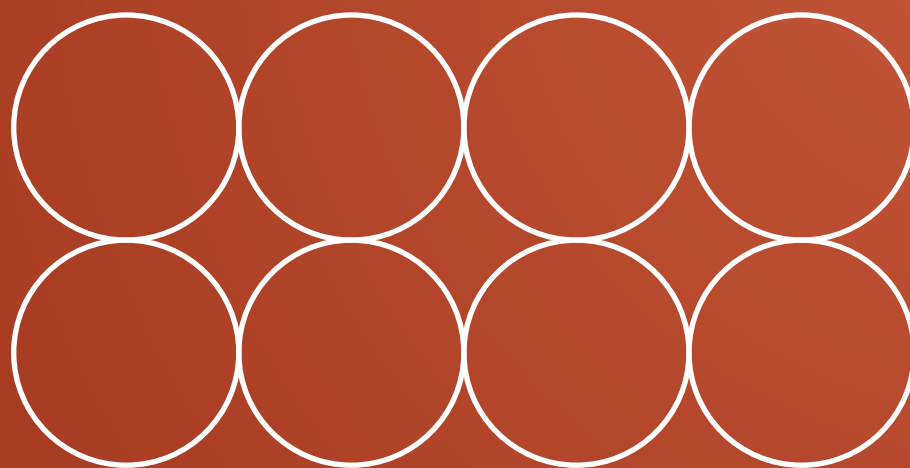

# КАТАЛОГ ПРОДУКТІВ KG

## ТРУБИ З РОЗТРУБОМ (KGEM) - CO-EXTRUDED EN 13476

### Class A - SN2

DN	d <sub>1</sub> [mm]	s <sub>1</sub> [mm]	D [mm]	t [mm]	L [mm]	Art. No.
160	160	3,2	183	110	500	22048
160	160	3,2	183	110	1000	22050
160	160	3,2	183	110	2000	22060
160	160	3,2	183	110	3000	22063
160	160	3,2	183	110	6000	22080
200	200	3,9	226	120	1000	23050
200	200	3,9	226	120	2000	23060
200	200	3,9	226	120	3000	23063
200	200	3,9	226	120	6000	23080

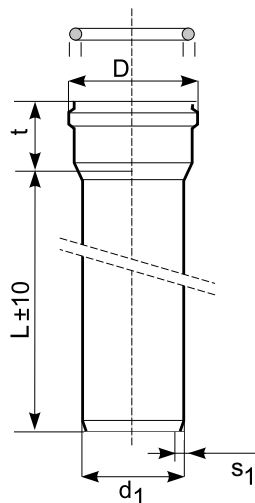

### Class B - SN4

DN	d <sub>1</sub> [mm]	s <sub>1</sub> [mm]	D [mm]	t [mm]	L [mm]	Art. No.
110	110	3,2	128	76	500	20000
110	110	3,2	128	76	1000	20010
110	110	3,2	128	76	2000	20020
110	110	3,2	128	76	3000	20023
110	110	3,2	128	76	6000	20040
160	160	4,0	183	110	500	22000
160	160	4,0	183	110	1000	22010
160	160	4,0	183	110	2000	22020
160	160	4,0	183	110	3000	22023
160	160	4,0	183	110	6000	22040
200	200	4,9	226	120	500	23000
200	200	4,9	226	120	1000	23010
200	200	4,9	226	120	2000	23020
200	200	4,9	226	120	3000	23023
200	200	4,9	226	120	6000	23040
250	250	6,2	287	140	2000	24020
250	250	6,2	287	140	3000	24023
250	250	6,2	287	140	6000	24040
315	315	7,7	355	160	2000	25020
315	315	7,7	355	160	3000	25023
315	315	7,7	355	160	6000	25040
400	400	9,8	445	190	2000	26020
400	400	9,8	445	190	3000	26023
400	400	9,8	445	190	6000	26040

## Class C - SN8

DN	d <sub>1</sub> [mm]	s <sub>1</sub> [mm]	D [mm]	t [mm]	L [mm]	Art. No.
110	110	3,2	128	76	500	20005
110	110	3,2	128	76	1000	20015
110	110	3,2	128	76	2000	20025
110	110	3,2	128	76	3000	20028
110	110	3,2	128	76	6000	20045
160	160	4,7	183	110	500	22005
160	160	4,7	183	110	1000	22015
160	160	4,7	183	110	2000	22025
160	160	4,7	183	110	3000	22028
160	160	4,7	183	110	6000	22045
200	200	5,9	226	120	1000	23015
200	200	5,9	226	120	2000	23025
200	200	5,9	226	120	3000	23028
200	200	5,9	226	120	6000	23045
250	250	7,3	287	140	2000	24025
250	250	7,3	287	140	3000	24028
250	250	7,3	287	140	6000	24045
315	315	9,2	355	160	2000	25025
315	315	9,2	355	160	3000	25028
315	315	9,2	355	160	6000	25045
400	400	11,7	445	190	2000	26025
400	400	11,7	445	190	3000	26028
400	400	11,7	445	190	6000	26045
500	500	14,6	567	220	3000	27028
500	500	14,6	567	220	6000	27045

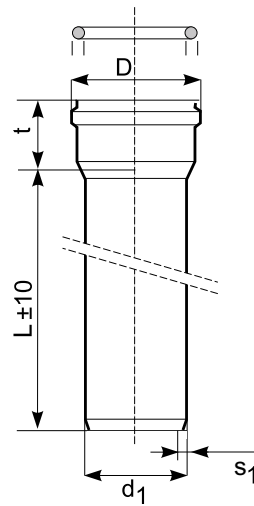

# ТРУБИ З РОЗТРУБОМ - ЛИТА СТІНКА (KGEL) EN 1401

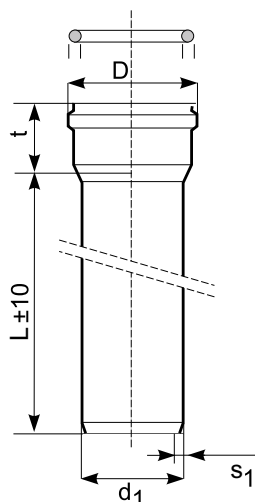

## Class B - SN4

DN	d <sub>1</sub> [mm]	s <sub>1</sub> [mm]	D [mm]	t [mm]	L [mm]	Art. No.
160	160	4,0	183	110	1000	222010
160	160	4,0	183	110	2000	222020
160	160	4,0	183	110	3000	222023
160	160	4,0	183	110	6000	22040
200	200	4,9	226	120	1000	223010
200	200	4,9	226	120	2000	223020
200	200	4,9	226	120	3000	223023
200	200	4,9	226	120	6000	223040
250	250	6,2	287	140	3000	224023
250	250	6,2	287	140	6000	224040
315	315	7,7	355	160	3000	225023
315	315	7,7	355	160	6000	225040

## Class C - SN8

DN	d <sub>1</sub> [mm]	s <sub>1</sub> [mm]	D [mm]	t [mm]	L [mm]	Art. No.
110	110	3,2	128	76	1000	220015
110	110	3,2	128	76	2000	220025
110	110	3,2	128	76	3000	220028
110	110	3,2	128	76	6000	220045
160	160	4,7	183	110	1000	222015
160	160	4,7	183	110	2000	222025
160	160	4,7	183	110	3000	222028
160	160	4,7	183	110	6000	222045
200	200	5,9	226	120	1000	223015
200	200	5,9	226	120	2000	223025
200	200	5,9	226	120	3000	223028
200	200	5,9	226	120	6000	223045
250	250	7,3	287	140	2000	224025
250	250	7,3	287	140	3000	224028
250	250	7,3	287	140	6000	224045
315	315	9,2	355	160	2000	225025
315	315	9,2	355	160	3000	225028
315	315	9,2	355	160	6000	225045
400	400	11,7	445	190	2000	226025
400	400	11,7	445	190	3000	226028
400	400	11,7	445	190	6000	226045
500	500	14,6	567	220	3000	227028
500	500	14,6	567	220	6000	227045

## КОЛІНА (KGB)

DN	angle	$z_1$ [mm]	L [mm]	Art. No.
110	15°	8	84	20100
110	30°	14	85	20110
110	45°	29	85	20120
110	67°	40	104	20130
110	87°	69	123	20140
160	15°	32	88	22100
160	30°	40	135	22110
160	45°	47	135	22120
160	67°	96	170	22130
160	87°	64	142	22140
200	15°	26	133	23100
200	30°	49	160	23110
200	45°	65	160	23120
200	67°	68	168	23130
200	87°	105	245	23140
250	15°	19	170	24100
250	30°	37	189	24110
250	45°	57	189	24120
250	87°	132	283	24130
315	15°	23	198	25100
315	30°	47	221	25110
315	45°	72	221	25120
315	87°	166	340	25130
400	15°	29	238	26100
400	30°	59	268	26110
400	45°	91	268	26120
400	87°	211	419	26130
500	15°	37	279	27100
500	30°	74	317	27110
500	45°	114	317	27120
500	87°	263	506	27130

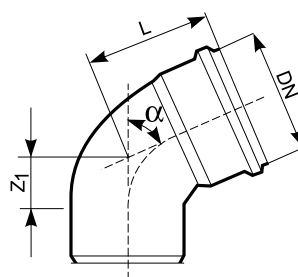

# ТРІЙНИКИ (KGEA)

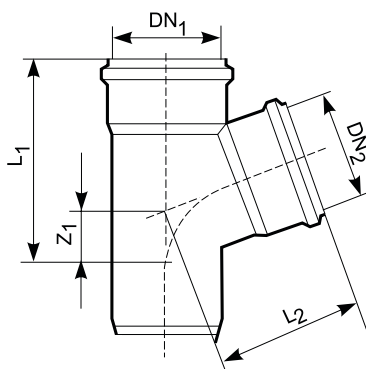

DN1/ DN2	angle	z <sub>1</sub> [mm]	L <sub>1</sub> [mm]	L <sub>2</sub> [mm]	Art. No.
110/110	45°	27	226	201	20300
160/110	45°	16	244	252	20330
160/160	45°	38	317	283	20350
200/110	45°	17	280	271	20360
200/160	45°	20	337	327	20380
200/200	45°	46	402	359	20390
250/110	45°	30	394	294	22300
250/160	45°	33	472	396	22320
250/200	45°	48	397	396	22330
250/250	45°	50	560	530	22340
315/110	45°	34	371	407	23300
315/160	45°	15	415	395	23320
315/200	45°	5	457	438	23330
315/250	45°	15	650	515	23340
315/315	45°	45	645	600	23350
400/160	45°	7	563	488	24320
400/200	45°	8	540	521	24330
400/250	45°	95	905	620	24340
400/315	45°	9	817	680	24350
400/400	45°	14	878	740	24360
500/160	45°	112	480	520	25320
500/200	45°	85	534	561	25330
500/250	45°	34	734	720	25340
500/315	45°	38	888	770	25350
500/400	45°	52	927	870	25360
110/110	87°	55	186	142	21300
160/110	87°	83	240	178	21330
160/160	87°	116	297	213	21350
200/110	87°	109	304	166	21360
200/160	87°	143	352	216	21380
200/200	87°	144	381	230	21390
250/110	87°	62	317	256	22305
250/160	87°	88	388	285	22325
250/200	87°	107	422	310	22335
250/250	87°	115	439	345	22345
315/110	87°	67	352	266	23305
315/160	87°	90	415	315	23325
315/200	87°	100	450	340	23335
315/250	87°	115	480	380	23345
315/315	87°	135	525	430	23355
400/160	87°	80	465	415	24325
400/200	87°	95	495	438	24335
400/250	87°	120	535	465	24345
400/315	87°	145	585	490	24355
400/400	87°	180	640	530	24365
500/160	87°	205	640	390	25325
500/200	87°	220	665	415	25335
500/250	87°	230	690	450	25345
500/315	87°	260	765	500	25355
500/400	87°	295	845	555	25365

## ЗАГЛУШКИ (KGM)

DN	L [mm]	D [mm]	Art. No.
110	32	120	20220
160	42	170	22220
200	50	217	23220
250	80	265	24220
315	80	333	25220
400	80	423	26220
500	80	525	27220

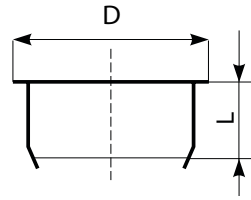

## ЗАГЛУШКИ КІНЦЕВІ (KGK)

DN	L [mm]	Art. No.
110	43	20240
160	52	22240
200	64	23240
250	68	24240
315	77	25240
400	90	26240

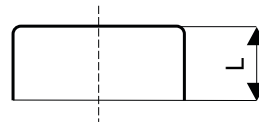

## МУФТИ (KGU)

DN	L [mm]	Art. No.
110	105	20180
160	138	22180
200	215	23180
250	250	24180
315	293	25180
400	324	26180
500	380	27180

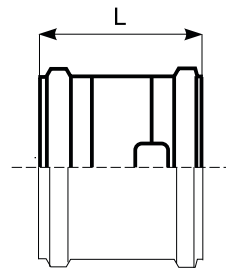



## ДВОРОЗТРУБНИЙ З'ЄДНУВАЧ (KG-ERMM)

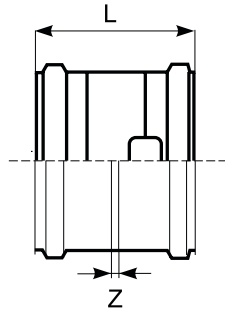

DN	Z [mm]	L [mm]	Art. No.
110	3	105	20200
160	3	138	22200
200	5	215	23200
250	7	250	24200

## РЕДУКЦІЇ (KGR)

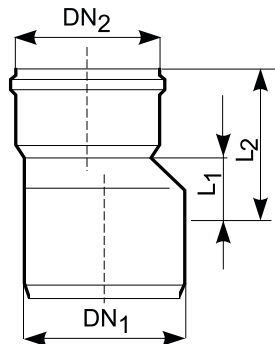

DN1/DN2	L <sub>1</sub> [mm]	L <sub>2</sub> [mm]	Art. No.
160/110	46	118	21280
200/160	48	143	23280
250/200	147	264	24280
315/250	214	342	25280
400/315	243	385	26280
500/400	150	340	27280

## MULTI-STAGE REDUCTIONS (KGR)

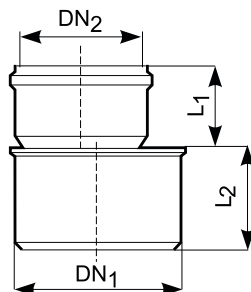

DN1/DN2	L <sub>1</sub> [mm]	L <sub>2</sub> [mm]	Art. No.
250/160	113	130	24283
315/160	113	141	25283
315/200	118	147	25284

## ПЕРЕХІДНИК НА ЦЕМЕНТНУ ТРУБУ (KGUS)

DN	D [mm]	L [mm]	Art. No.
110	138	151	20410
160	194	207	22410
200	250	248	23410

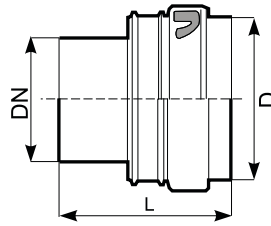

DN	D [mm]	L [mm]	Art. No.
250*	315	283	24400
315*	400	318	25400

\* для з'єднувачів з ЦЕМЕНТНИМИ ТРУБАМИ  
KGUS 250 та 315 KGUS слід замовляти  
ущільнювач ОКРЕМО

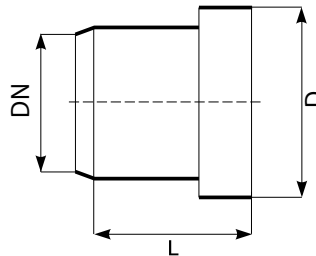

## ПЕРЕХІД НА ЧАВУННУ ТРУБУ (KGUG)

DN	d <sub>1</sub> [mm]	L [mm]	Art. No.
110**	124	60	20440
160**	187	98	22440
200**	242	103	23440

\*\* для перехідників на чавунні труби KGUG DN  
110-200 ущільнювачі слід замовляти ОКРЕМО

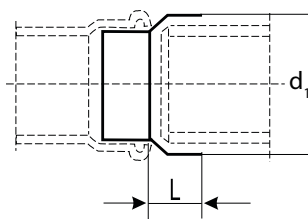

## РЕВІЗІЇ (KGRE) з різьбовою кришкою

DN	Z <sub>1</sub> [mm]	L [mm]	Art. No.
110	58	179	20160
250	128	722	24160

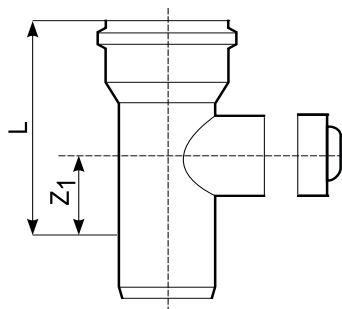

## РЕВІЗІЇ (KGRE) з кришкою на болтах

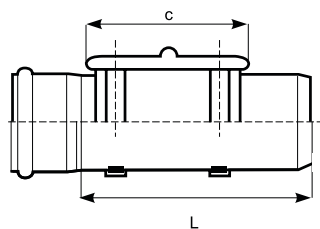

DN	c	L [mm]	Art. No.
110	221	279	20161
160	282	332	22160
200	394	494	23160

## WALL SLEEVES (KGF)

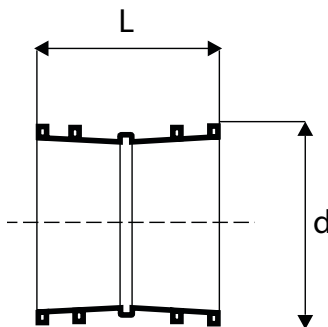

DN	L [mm]	d [mm]	Art. No.
110	110	131	20600
160	110	184	22600
200	110	226	23600
250	110	286	24600
315	110	354	25600
400	110	440	26600
110	240	137	20620
160	240	190	22620
200	240	231,5	23620
250	240	290	24620
315	240	359	25620
400	240	448	26620
500	240	554	27620

## УЩІЛЬНЮВАЧІ



Pipes	DN	Art. No.
KG	110	7200
KG	160	7220
KG	200	7230
KG	250	7240
KG	315	7250
KG	400	7260
KG	500	7270
<b>з'єднувач з чавунними трубами</b>		
KGUG	110	20460
KGUG	160	22460
KGUG	200	23460
<b>з'єднувач з цементними трубами</b>		
KGUS	250	24500
KGUS	315	25500



РІШЕННЯ  
НА РОКИ



# РІШЕННЯ НА РОКИ

---

**magnoplast**